

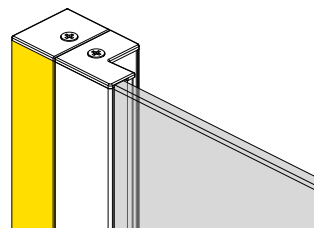

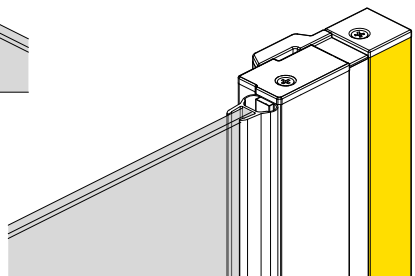

- | | | | |
|------------|-------------------------|-----------|-----------------------------|
| PL | Instrukcja montażu | UA | Інструкція по установці |
| GB | Assembly instruction | H | Szerelési útmutató |
| D | Montageanleitung | RO | Instructiuni de montaj |
| SK | Návod na inštaláciu | FR | Instruction de montage |
| CZ | Pokyny k instalaci | IT | Istruzioni di montaggio |
| RUS | Инструкция по установке | ES | Instrucciones de ensamblaje |
| | | AE | تعليمات التجميع |

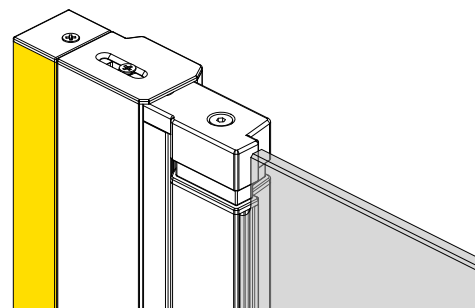
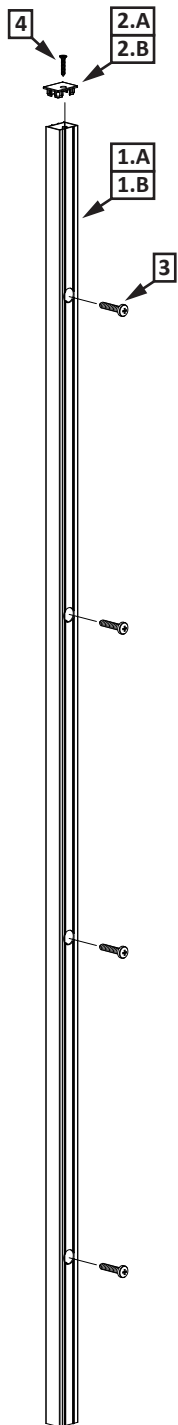

NES +20mm

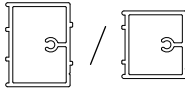
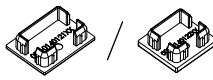
- | | | | |
|-----------|---------------------|------------|------------------------|
| PL | Profil poszerzający | RUS | Расширительный профиль |
| GB | Extension profile | UA | Розширений профіль |
| D | Verbreitungsprofil | RO | Profile de extensie |
| SK | Rozširovací profil | H | Toldóprofilok |
| CZ | Rozšiřující profil | | |

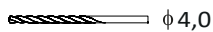

Nr Nr No. číslo počet № Sorszám Numar	Oznaczenie Mark Bezeichnung Označenje Označení обозначение Jelölés Componenta	Sztuk Pcs. Stück Kus KS штук db. Bucati
1.A / 1.B		1
2.A / 2.B		1
3.	 4,8x13 DIN 7981	4
4.	 2.9x13 DIN 7982	1
5.	 $\phi 4,0$	1
6.	 $\phi 8$	4
7.	 5x40 DIN 7981	4

NES

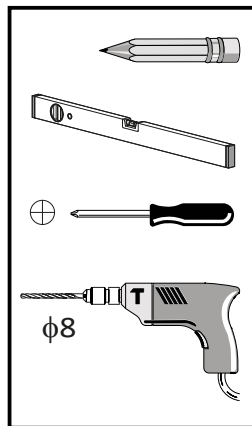
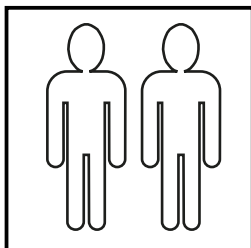

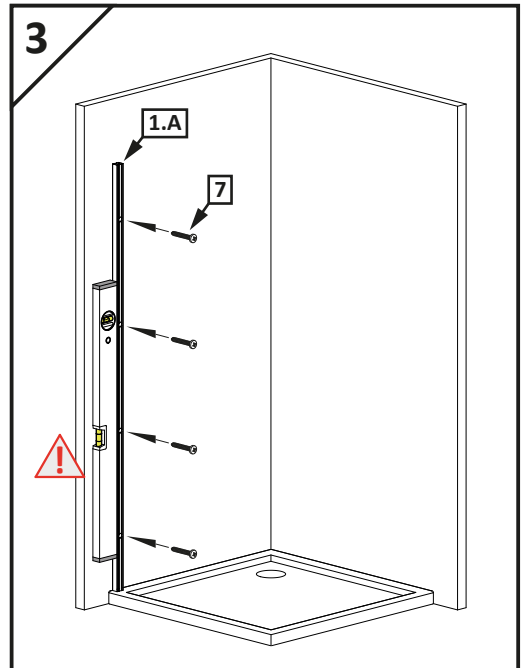
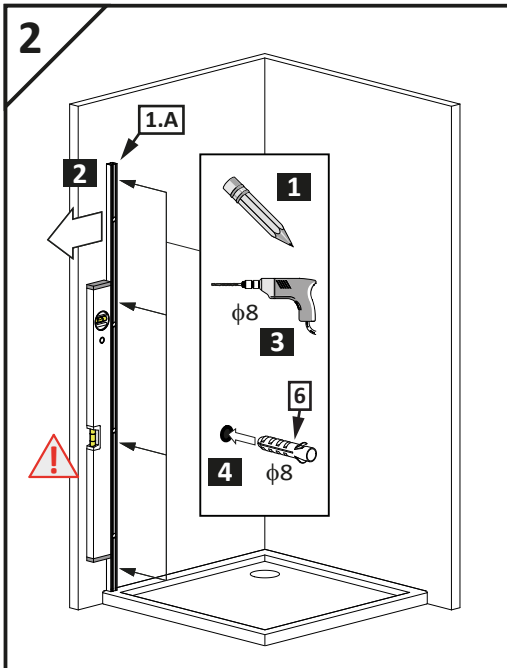
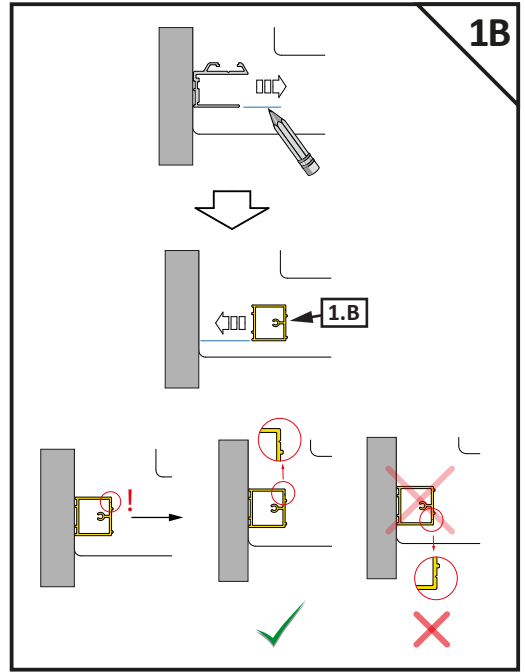
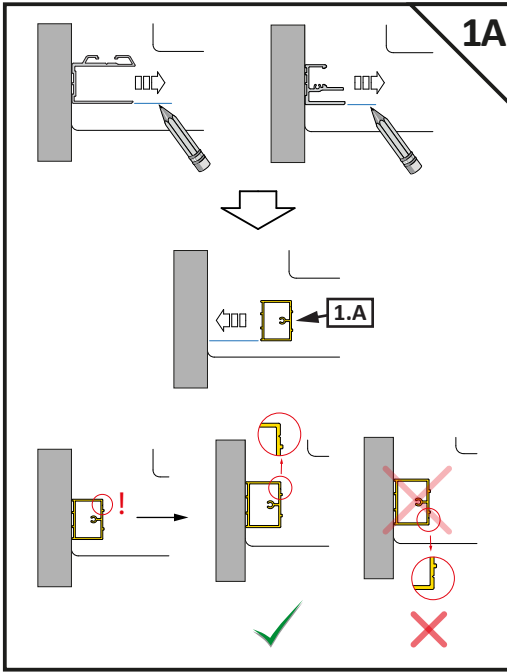

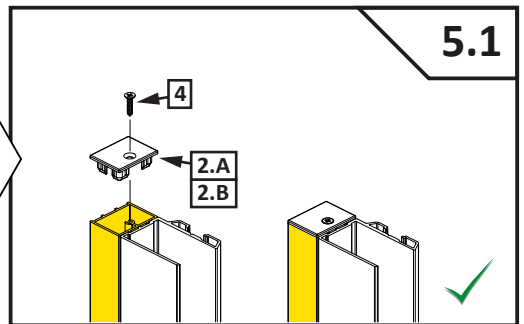
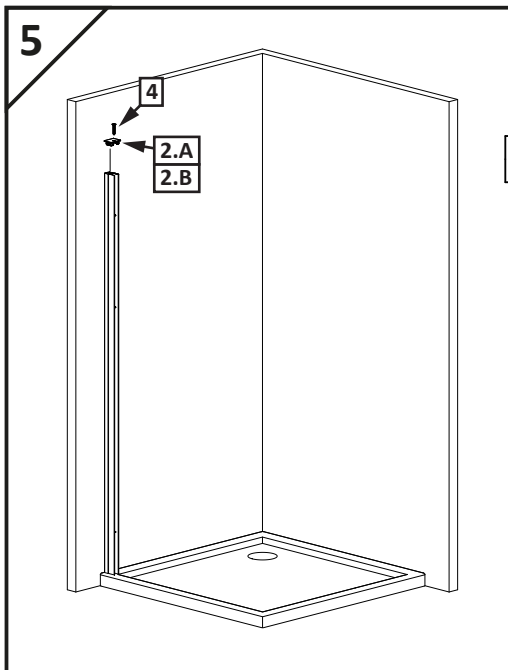
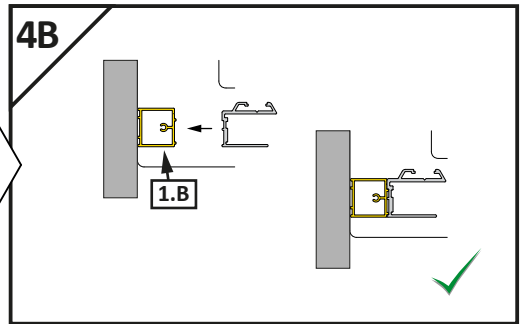
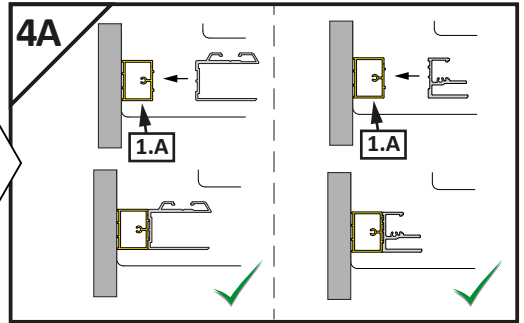
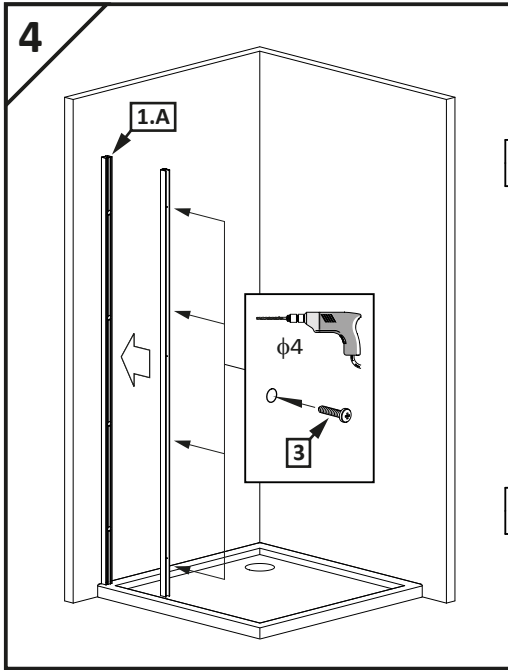

6

radaway **NES**

PL	Instrukcja montażu	H	Szerelési útmutató
GB	Assembly instruction	RO	Instructiuni de montaj
D	Montageanleitung	FR	Instruction de montage
SK	Návod na inštaláciu	IT	Istruzioni di montaggio
CZ	Pokyny k instalaci	ES	Instrucciones de ensambleaje
RUS	Инструкция по установке	AE	تعليمات التجميع
UA	Інструкція по установці		