

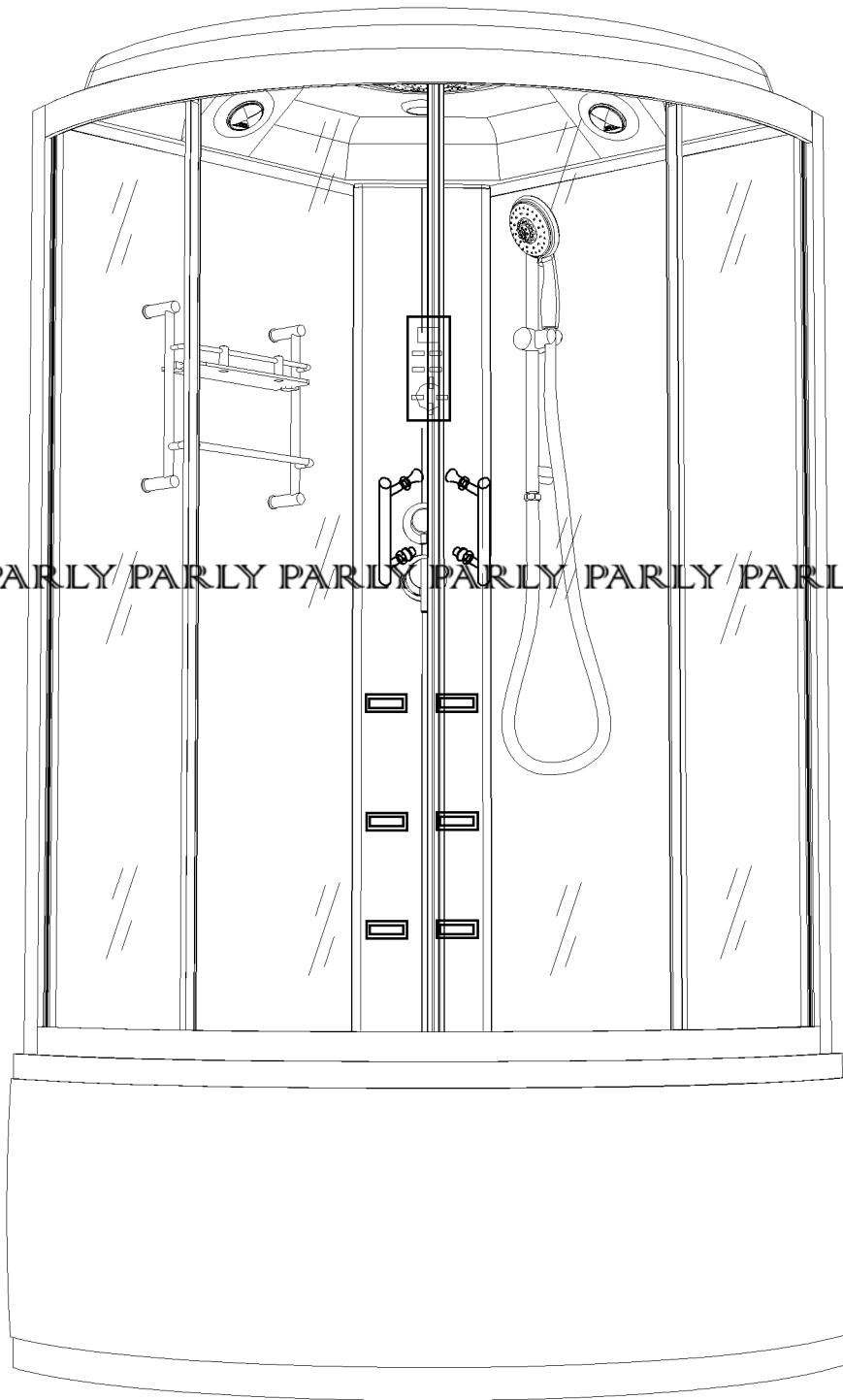

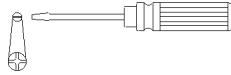

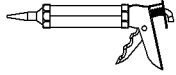

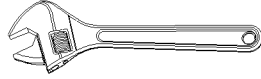



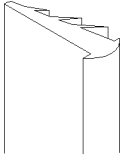
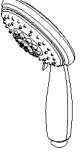

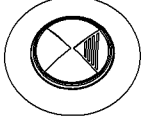
SP90/100/118 SP91/SP101

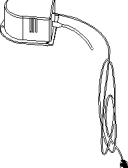

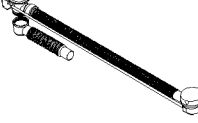
PARLY PARLY PARLY/PARLY/PARLY/PARLY/PARLY/PARLY/PARLY/PARLY/PARLY/PARLY

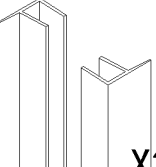
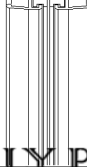
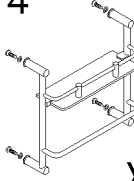

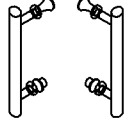
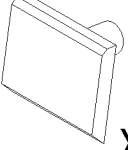
<p>A1</p>  <p>X1</p>	<p>A2</p>  <p>X2</p>	<p>A3</p>  <p>X1</p>	<p>A4</p>  <p>X1</p>	<p>A5</p>  <p>X1</p>
<p>A6</p>  <p>X2</p>	<p>A7</p>  <p>L=1.5M X1</p>	<p>A8</p>  <p>X1</p>	<p>A9</p>  <p>X4</p>	<p>A10</p>  <p>X1</p>
<p>A1</p>  <p>X1</p>	<p>A12</p>  <p>X2</p>	<p>A13</p>  <p>X1</p>	<p>A14</p>  <p>X1</p>	<p>A15</p>  <p>X4</p>
<p>A16</p>  <p>X2</p>	<p>A17</p>  <p>X1</p>			

PARLY PARLY PARLY PARLY PARLY PARLY PARLY PARLY PARLY PARLY

Ø2.8

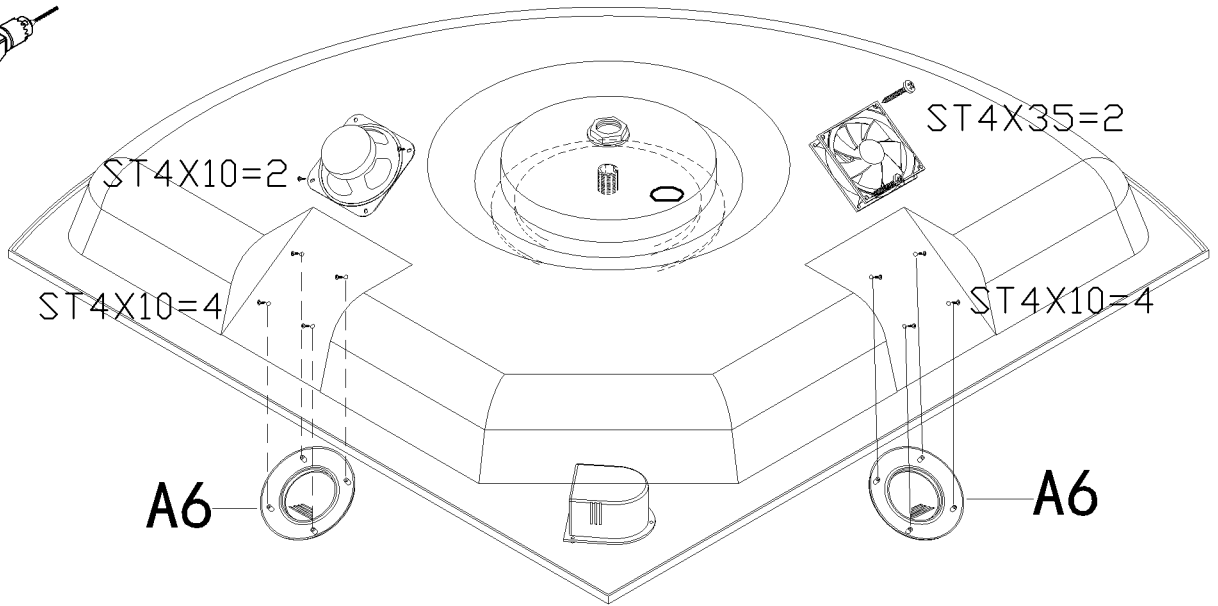
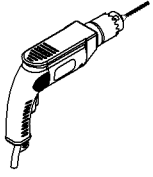

PARTLY PARTLY PARTLY PARTLY PARTLY PARTLY PARTLY PARTLY PARTLY PARTLY

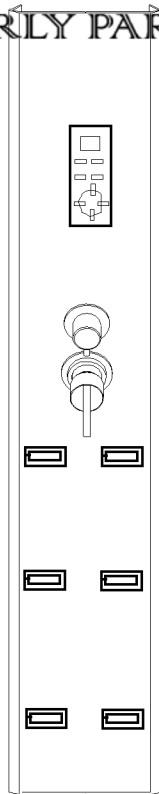

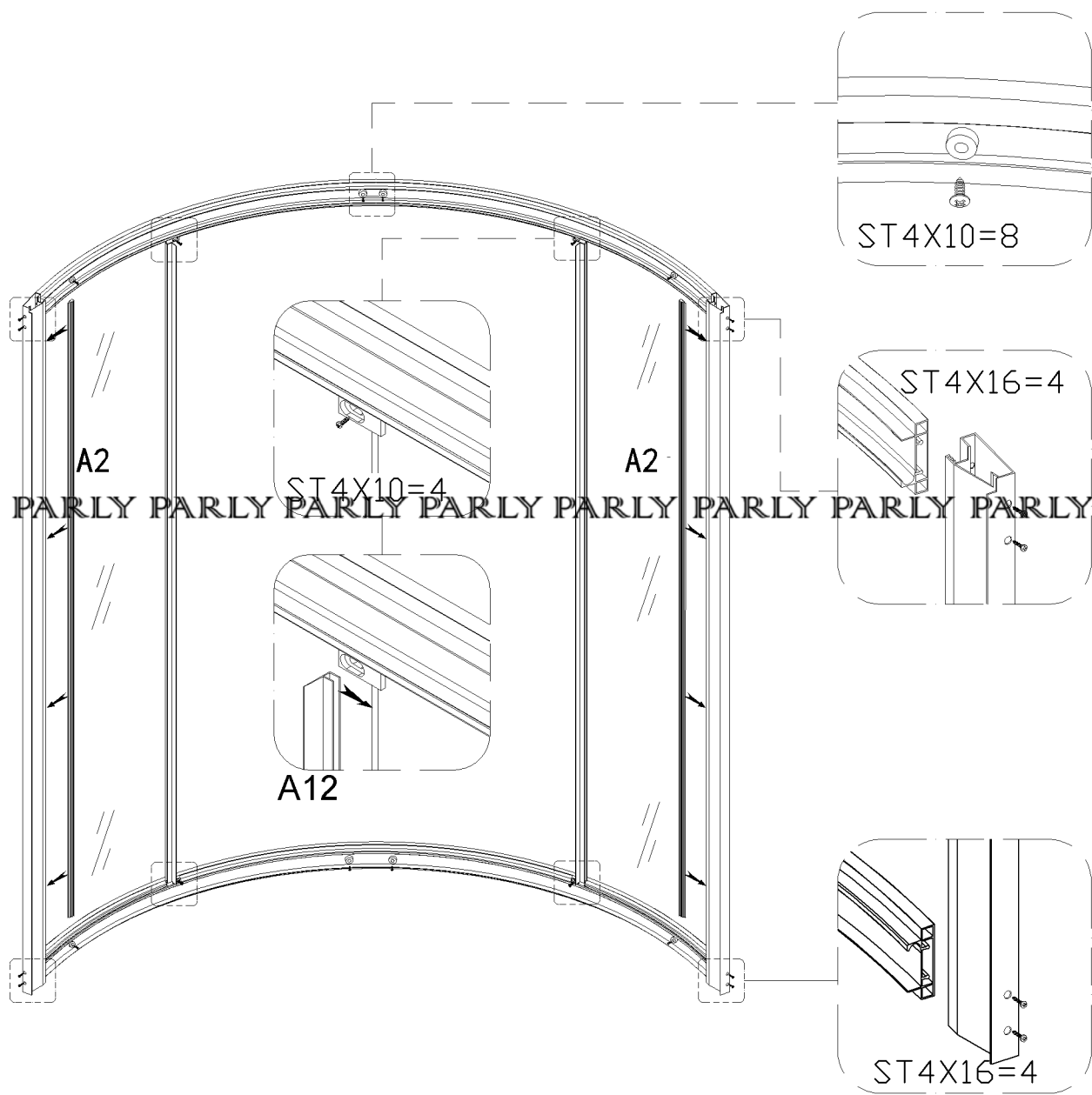

PARLY PARLY PARLY PARLY PARLY PARLY PARLY PARLY PARLY PARLY

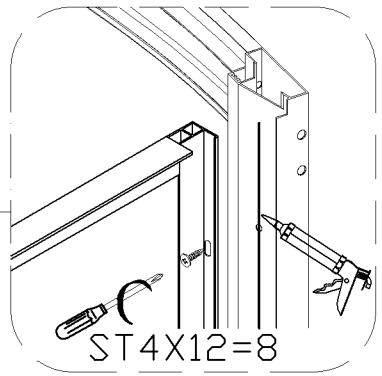
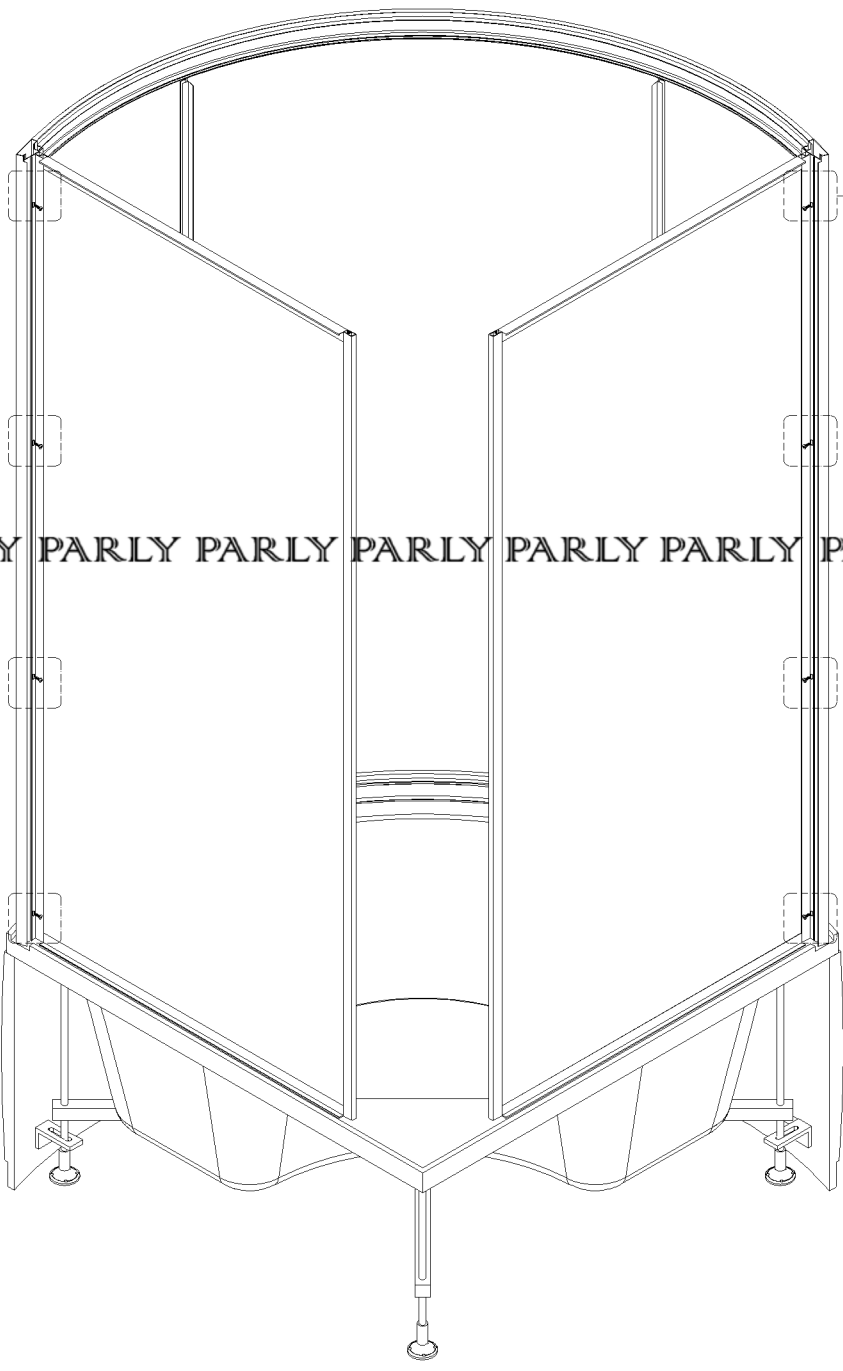

PARLY PARLY PARLY PARLY PARLY PARLY PARLY PARLY PARLY PARLY

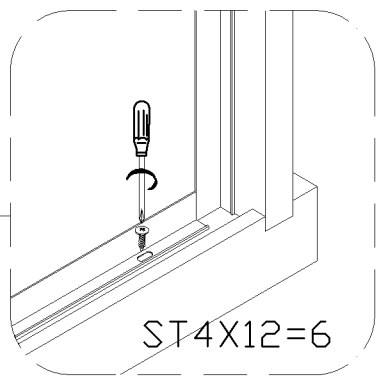
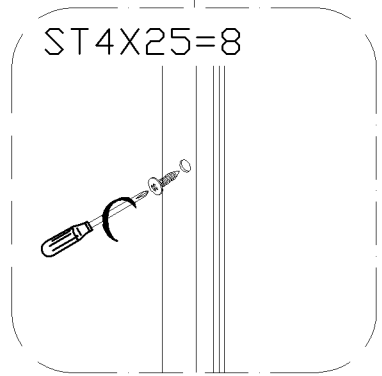
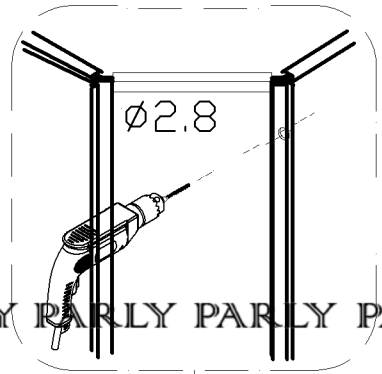
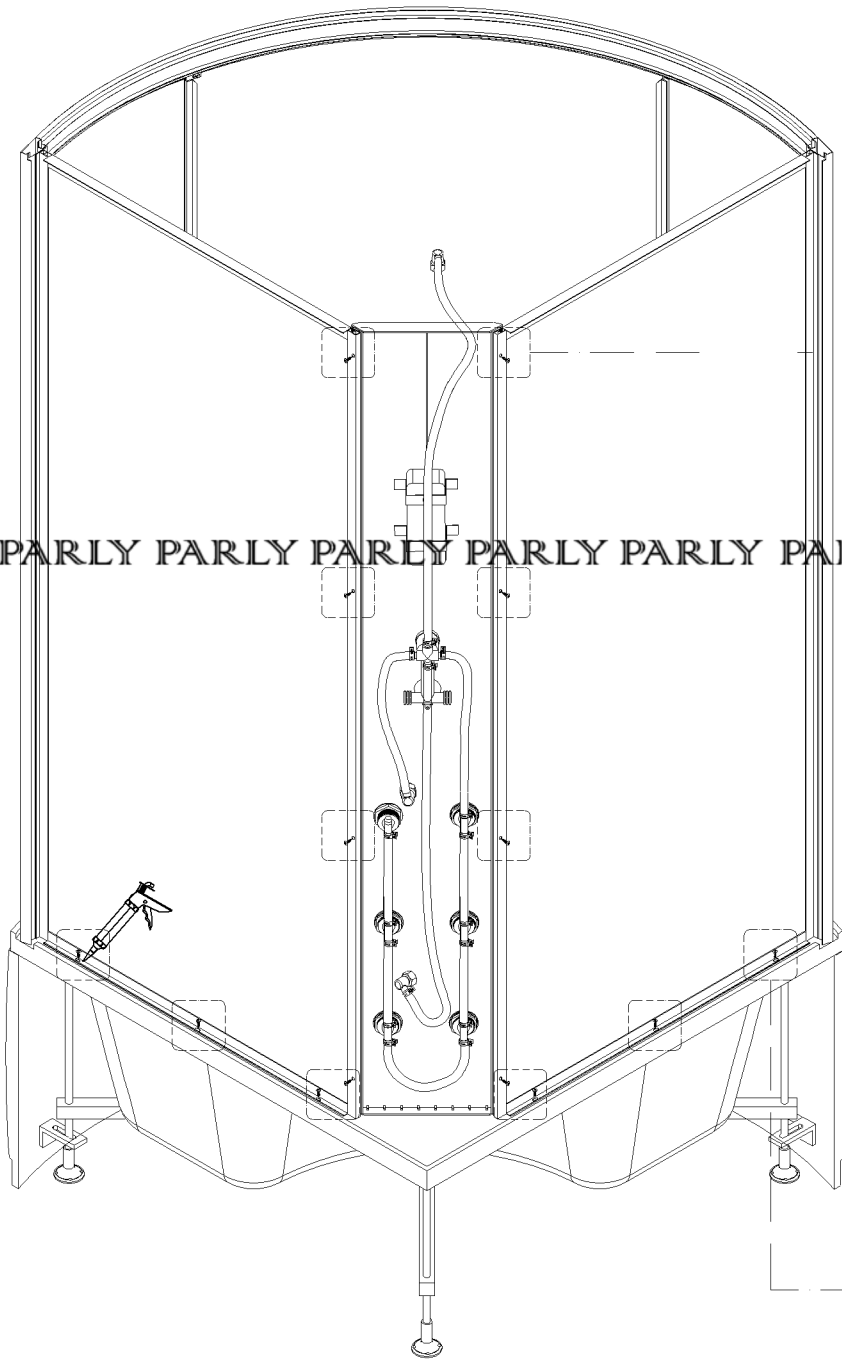

PARLY PARLY PARLY PARLY PARLY PARLY PARLY PARLY PARLY PARLY

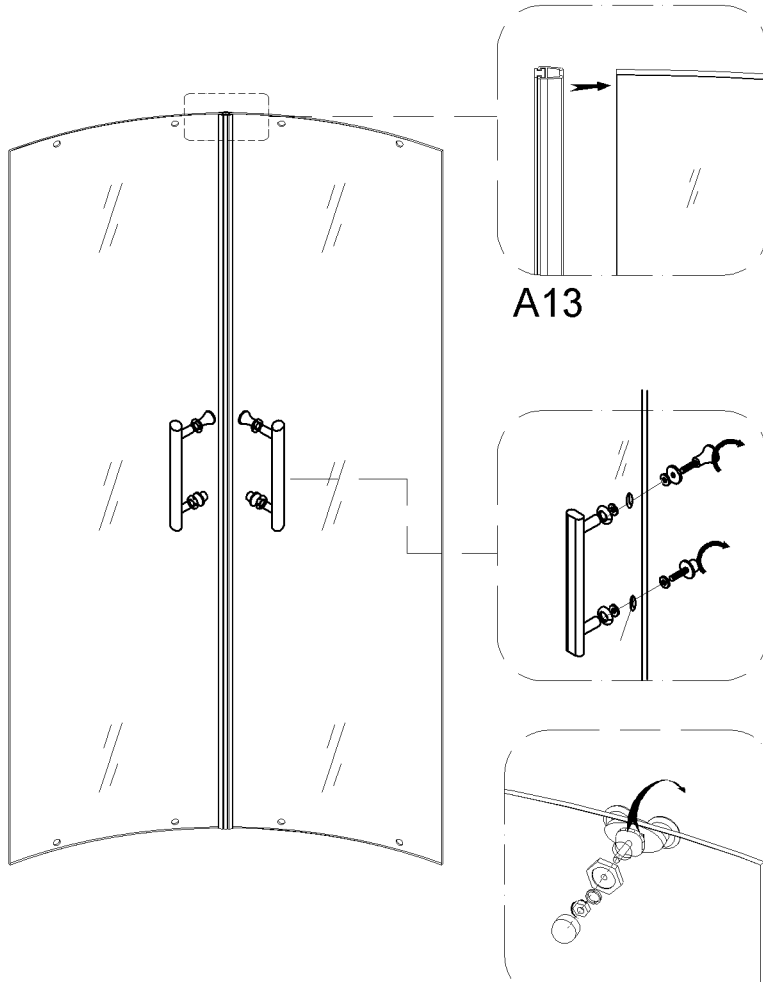

A13

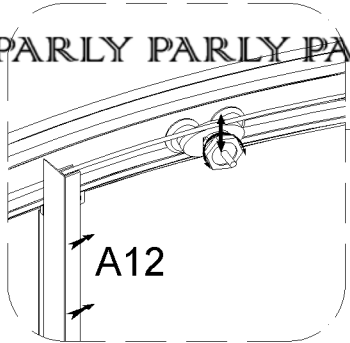

A12

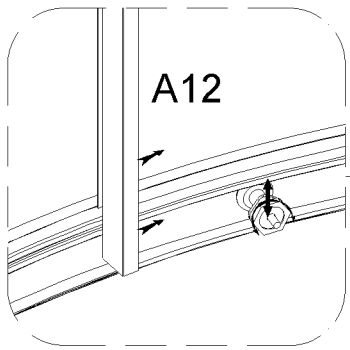

A12

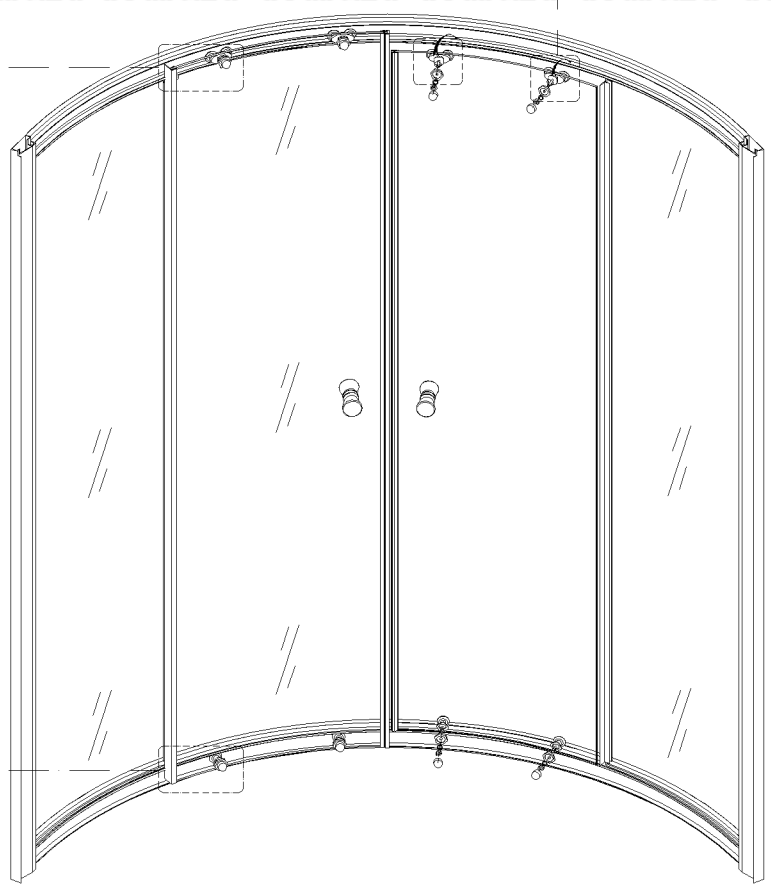

PARTY PARTY PARTY PARTY PARTY PARTY PARTY PARTY PARTY PARTY

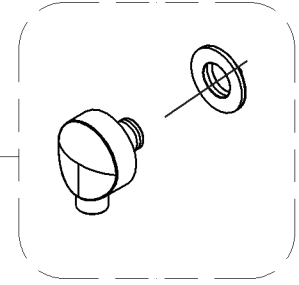
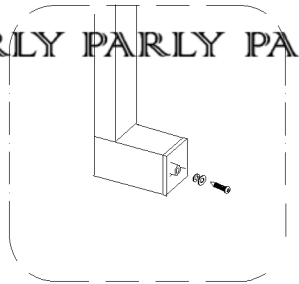
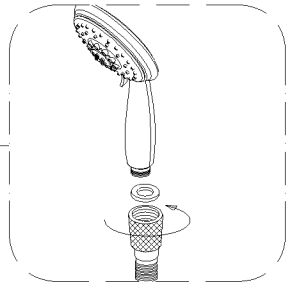
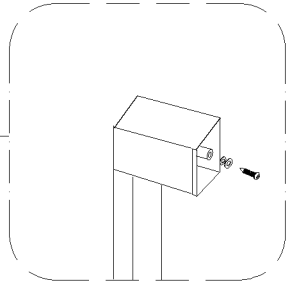
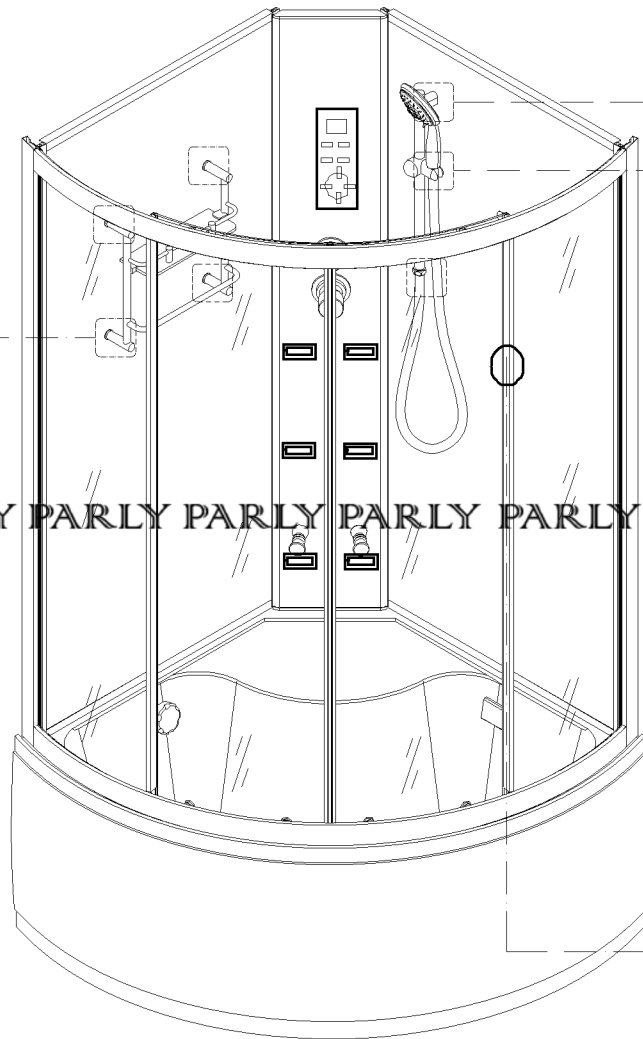
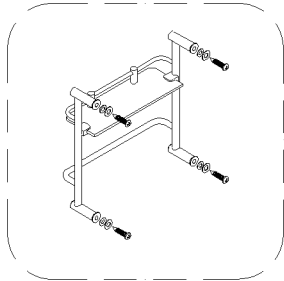

PARLY PARLY PARLY PARLY PARLY PARLY PARLY PARLY PARLY PARLY

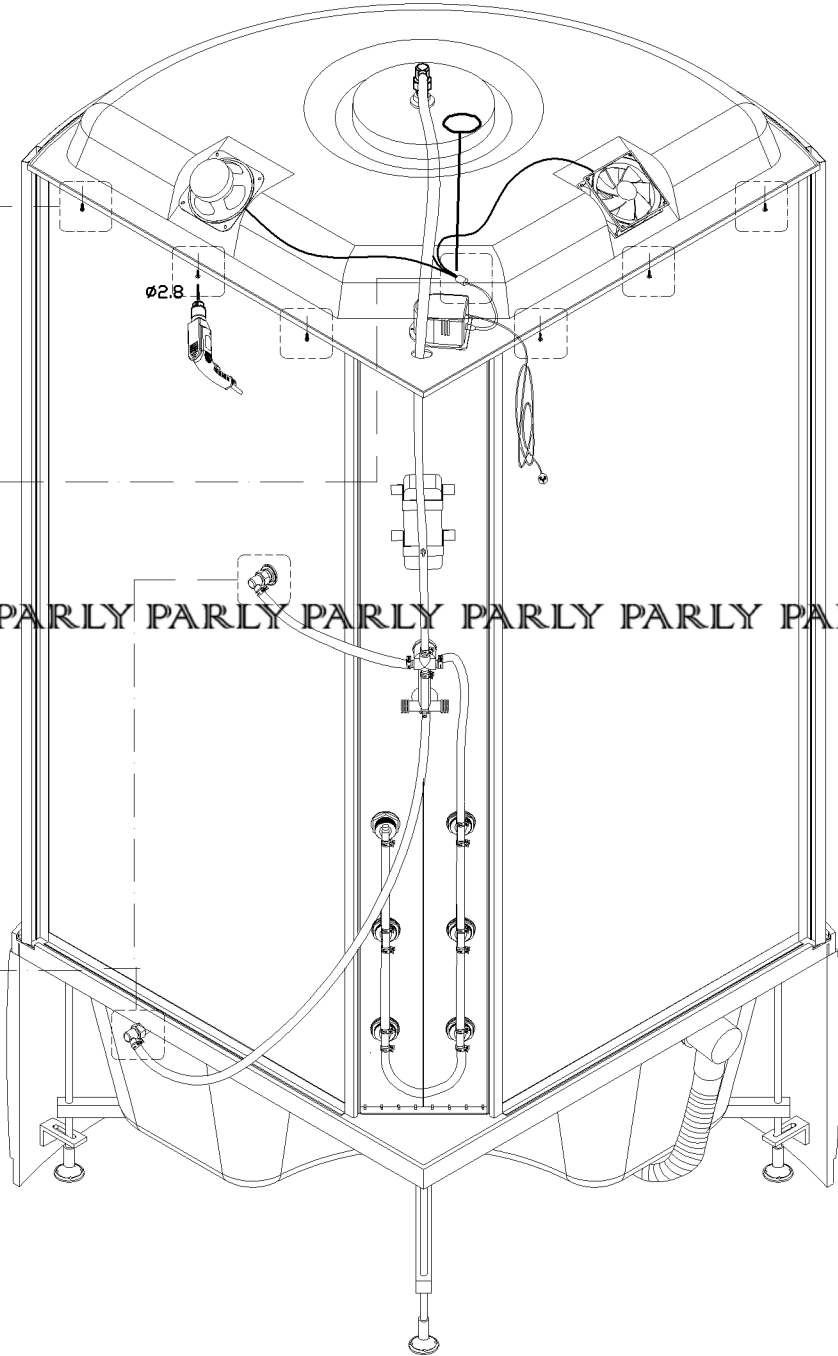
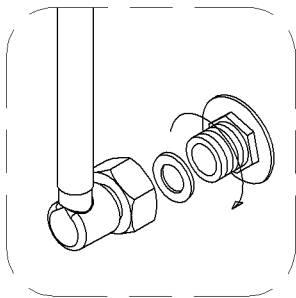
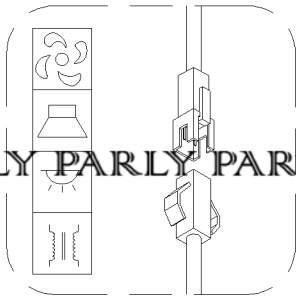
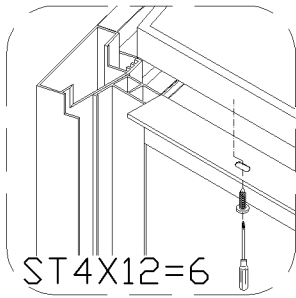
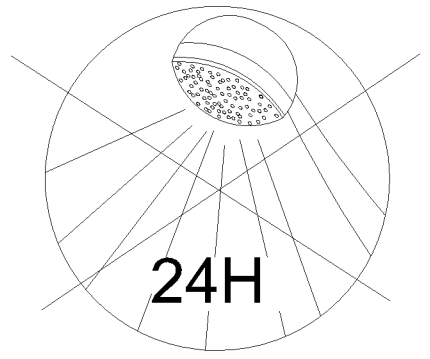

PARLY PARLY PARLY PARLY PARLY PARLY PARLY PARLY PARLY PARLY